

## 3 WAY WATER VALVE 180°

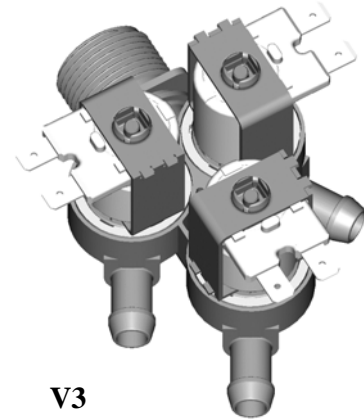
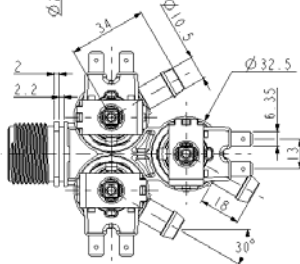
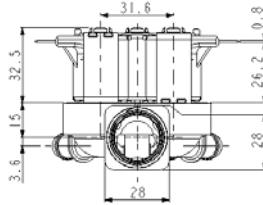
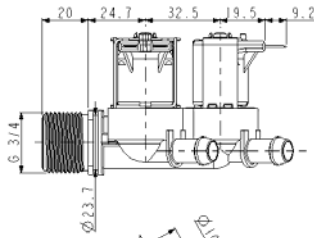

V1

V3

V2

Part of an extensive range of normally closed, pilot operated solenoid valves for use in many sectors where there is a need to control the supply of inlet water. Applications include drinks vending, water softeners, showers, air conditioning systems, irrigation and glass washers.

This range is fully flexible and can be designed and produced to meet individual requirements.

### Technical Data

Rated Voltage	220-240 vac, 110-120 vac, 24 vac & 12 vac. Others upon request.
Rated Frequency	50-60 Hz
Power Draw	6 Watts. (3 Watt DC servo-assisted - optional) at 230vac
Coil Insulation	Class F (140°C Operating Temperature)
Ambient Temperature	60 °C maximum.
Liquid Temperature	90°C maximum.
Operating Cycle Rate	Tu 25°C, Tm 90°C & Tu 60°C, Tm 25°C – Continuous (100% ED) Tu 60°C, Tm 90°C – 3 minutes ON, 5 minutes OFF
Operating Pressure Range	0.2 to 10 bar
Flow Regulator (optional)	0.25 to 17 Litres/minute
EMC	Fully compliant
Approvals	On Request
Insulation	Class II. Fully double insulated. No grounding required.
Terminals	Two 6.35 x 0.8mm male tab terminals.

The information, data and parameters given in this document are subject to change without notice

## REQUEST FOR QUOTATION

### Voltage Requirement

- 220-240VAC (standard)
- 220-240VAC (reinforced)
- 110-120VAC
- 24VAC/DC
- 12VAC/DC
- 12VAC/DC servo-assisted

### Terminal Direction

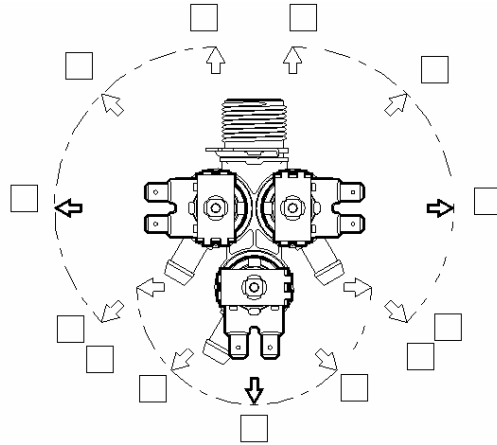

### Bracket Direction

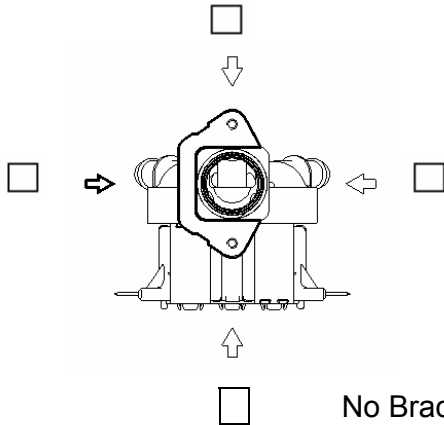

### Outlet Dimension



13 mm  10 mm

### Desired Flow Rate (1-10 bar)

Inlet  Litres/mn  
 Outlet V1  Litres/mn  
 Outlet V2  Litres/mn  
 Outlet V3  Litres/mn

Customer & Contact Name	
Contact No.	
Address	
Email Address	
Application	
Approvals Required	
Estimated Monthly Volumes	

### COIL TECHNICAL CHARACTERISTICS

Voltage	230V	230V	115V	12V Servo
Colour	Brown	Beige	Black	Green
Frequency	50/60 Hz	50/60 Hz	50/60 Hz	DC
Cycle 100%	Ambient 60°C Water 25°C	Ambient 60°C Water 25°C	Ambient 50°C Water 25°C	Ambient 60°C Water 25°C
Cycle 100%	Ambient 25°C Water 90°C	Ambient 25°C Water 90°C	Ambient 25°C Water 70°C	Ambient 25°C Water 90°C
Cycle 3min/ 5min	Ambient 60°C Water 90°C	Ambient 60°C Water 90°C	Ambient 50°C Water 70°C	Ambient 60°C Water 90°C
Resistance	3820Ω± 10%	4060Ω± 10%	1180 Ω± 10%	56 Ω± 10%
Power	5.8watt	5 watt	4 watt @ 50 Hz 3.2 watt @ 60 Hz	2.6 watt
Apparent Power	7.7 VA	6 VA	6.3 VA @ 50 Hz 5.4 VA @ 60 Hz	-
I Nominal	0.035 A	0.03 A	0.052 A @ 50 Hz 0.045 A @ 60 Hz	0.2 A

Voltage	24V AC	24V DC	12V AC	12V DC
Colour	Yellow	Yellow	Grey	Grey
Frequency	50/60 Hz	DC	50/60 Hz	DC
Cycle 100%	Ambient 60°C Water 25°C	Ambient 60°C Water 25°C	Ambient 60°C Water 25°C	Ambient 60°C Water 25°C
Cycle 100%	Ambient 25°C Water 90°C	Ambient 25°C Water 90°C	Ambient 25°C Water 90°C	Ambient 25°C Water 90°C
Cycle 3min/ 5min	Ambient 60°C Water 90°C	Ambient 60°C Water 90°C	Ambient 60°C Water 90°C	Ambient 60°C Water 90°C
Resistance	60 Ω± 10%	60Ω± 10%	14.5 Ω± 10%	14.5 Ω± 10%
Power	2.78watt	9.4 watt	-	9.0 watt
Apparent Power	4.6 VA	-	4.5 VA	-
I Nominal	0.190 A	0.390 A	0.38 A	0.8 A

## INLET REGULATORS

Colour	Flow Rate L/M	Tolerance %	Flow Rate GPM (US)
BROWN	5.00	15.00	1.32
LIGHT YELLOW	5.50	15.00	1.45
DARK BLUE	6.00	15.00	1.58
BEIGE	6.50	15.00	1.72
PALE ORANGE	8.00	15.00	2.11
BLACK	8.50	15.00	2.25
LIGHT BLUE	9.00	15.00	2.38
WHITE	10.00	15.00	2.64
GREEN	11.00	15.00	2.90
GREY	12.00	15.00	3.17
YELLOW	14.50	15.00	3.83
PINK	17.00	25.00	4.49



## OUTLET REGULATORS

Colour	Flow Rate L/M	Tolerance %	Flow Rate GPM (US)
GREY	0.35	28.00	0.09
YELLOW	0.50	30.00	0.13
GREEN	0.80	25.00	0.21
BLUE	1.20	25.00	0.32
BEIGE	1.30	25.00	0.34
PALE GREEN	2.00	25.00	0.53
BROWN	2.50	25.00	0.66
VIOLET	3.30	25.00	0.87
ORANGE	3.80	25.00	1.00
BLACK	5.00	15.00	1.32

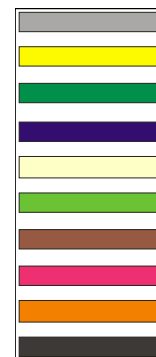

## VERNAY OUTLET REGULATORS

Colour	Code	Flow Rate L/M	Tolerance %	Flow Rate GPM (US)
BLACK	HD-DC	0.72	10.00	0.19
BLACK	DU-DC	0.57	10.00	0.15
BLACK	DL-DC	0.95	10.00	0.25
BLACK	HW-DC	1.89	10.00	0.50
BLACK	HY-DC	2.84	10.00	0.75
BLACK	DZ-DC	3.76	10.00	1.00
BLACK	CC-EP	2.27	10.00	0.60
BLACK	GJ-DC	1.25	10.00	0.33